

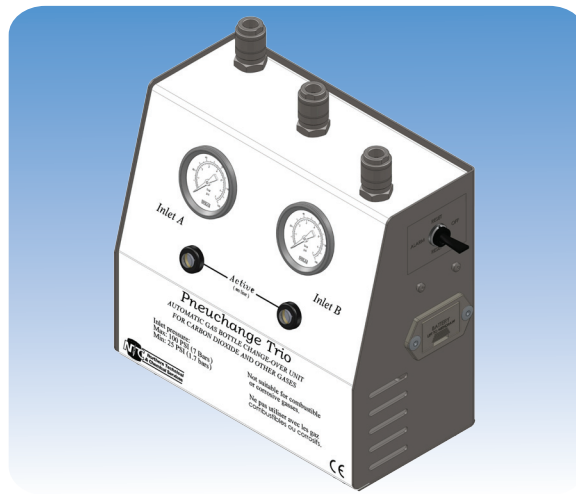

## Pneuchange Trio Mk.3 Series Automatic Gas Cylinder Change-Over Unit



### Installation and operating instructions PCTRIO

PNEUCHANGE inert Trio has been designed for  
CO<sub>2</sub> and other inert gases.

TD-8-059-IM1 Iss.B



## »»» TABLE OF CONTENTS

<b>Contents</b>	<b>PAGE</b>
Installation	3
Connecting Outlet Pressure Modules	3
Connecting Gas Supply	4
Operation	4
Warranty & Servicing	4
Alarm Facility	5
Port Adaptors	5
OPM's	5
Filter Assembly	6
Frequently Asked Questions	6 - 7

## »»» INSTALLATION

PNEUCHANGE TRIO can be installed at any point in the gas supply lines between the gas bottle regulators and the equipment being served, most conveniently situated where the operator can monitor it's operation. PNEUCHANGE TRIO can be free-standing on a horizontal surface or wall mounted.

This unit will release small amounts of gas into the working area when the automatic change-over takes place and when the outlet regulator is adjusted. Suitable ventilation must be present at all times when the unit is in use.

PNEUCHANGE TRIO can be wall mounted on suitable screws (not supplied) secured in keyholes as detailed in Fig.1.

N.B. OPENING THE UNIT WILL INVALIDATE THE WARRANTY.

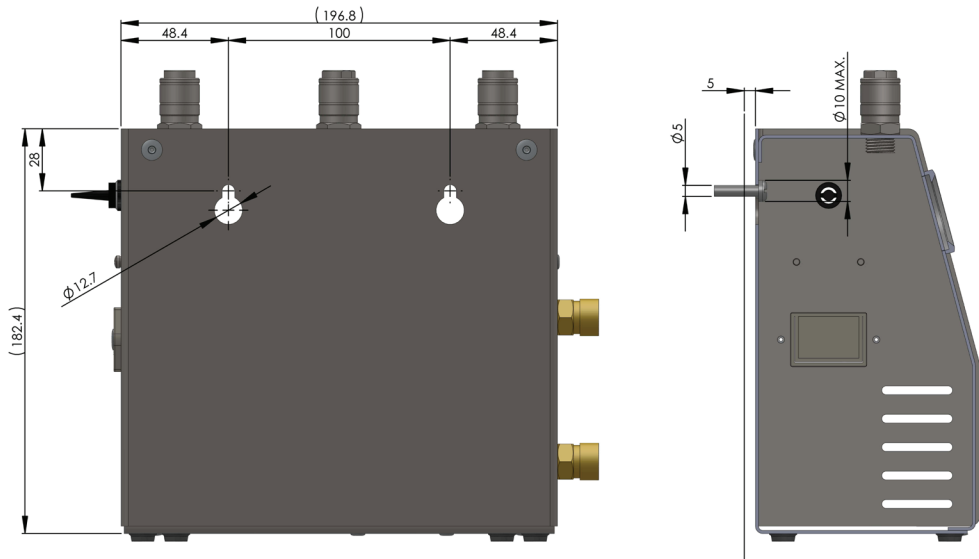

Fig.1

## »»» CONNECTING OUTLET PRESSURE MODULES

The outlet pressure module (OPM) is designed to push fit into any of the outlet ports on top of the PNEUCHANGE TRIO. The OPM can be fitted or removed while the unit is pressurised as the port will self seal when the OPM is removed by depressing the port outer sleeve.

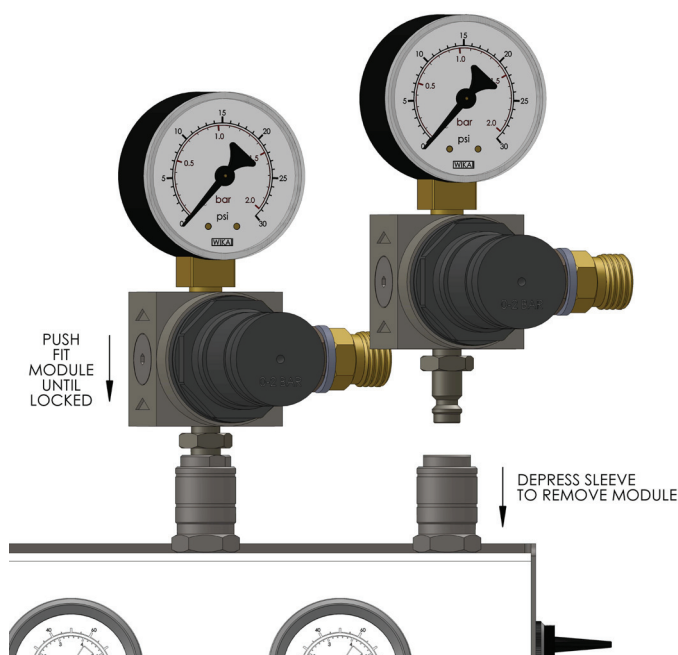

Fig.2

## CONNECTING GAS SUPPLIES

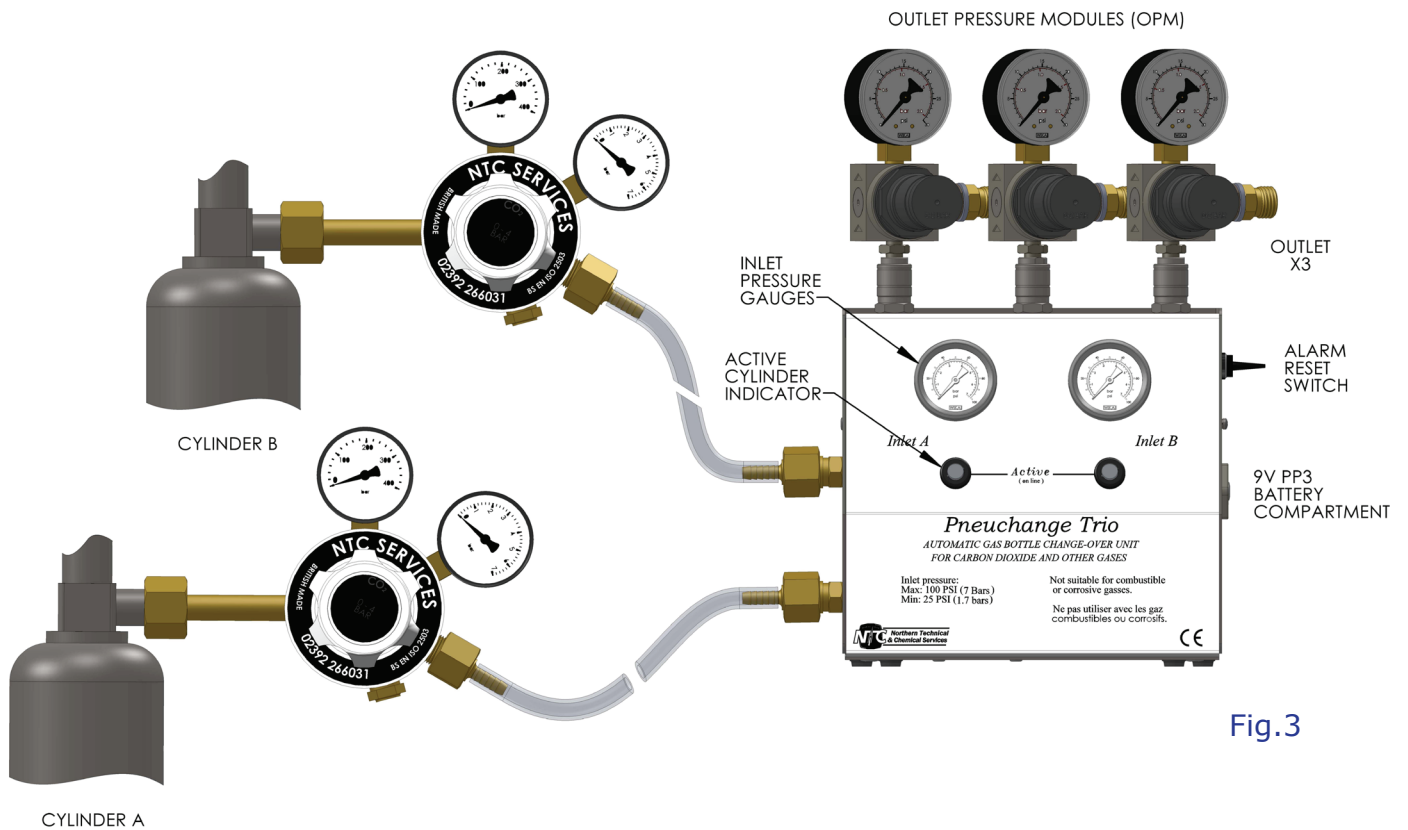

Fig.3

## OPERATION

Starting with two full cylinders regulated down to between 3.1 to 6.9bar [45 to 100psi], ensure PNEUCHANGE TRIO inlet gauges indicate cylinder regulator outlet pressures. Set the PNEUCHANGE TRIO outlet pressure modules (OPM's) to that required by the equipment (Incubators etc.) being served. This will be found in the manufacturer's instructions. The unit will feed from the first connected cylinder until this exhausts then the unit will automatically feed from the other cylinder. On replacing the empty cylinder *the unit will continue to feed from the currently active cylinder* until this is exhausted and the sequence will then repeat. No manual resetting is required.

## WARRANTY AND SERVICING

The NTC range of equipment supplied by The West Group Ltd carries a 12 month warranty. No special maintenance is required. Should repair or service be required after the warranty period the unit should be returned to The West Group Ltd for evaluation. Any attempted repair by unauthorised parties will invalidate the warranty. In line with BCGA codes of practice, we recommend that changeover units, regulators and hoses are replaced after 5 years.

The equipment supplied may contain a battery, if so please dispose of the battery according to the approved WEEE regulations, or return to the supplier.

## »»» ALARM FACILITY

PNEUCHANGE TRIO is fitted with an audible changeover alarm operated from a 9 volt PP3 type battery or equivalent. It is accessed via the battery drawer on the right hand side of the unit.

The alarm switch has two reset positions, one of which is constantly active.

- To use the alarm facility set the alarm switch to the inactive reset position.
- When cylinder changeover occurs, the alarm will sound.
- Switching to the opposite reset position will silence the alarm and set the unit for the next changeover alarm signal.
- Replace the empty cylinder as detailed under operation as shown above.

N.B. Alarm may sound prior to changeover

Setting the alarm to the 'off' position will remove the audible alarm facility, but PNEUCHANGE TRIO will continue to change cylinders as required.

The PNEUCHANGE TRIO alarm system detects differential pressure when Inlet B is active. The pressure switch requires minimum 1.4bar [20psi] rising pressure on side B to switch state before detecting 1.4bar [20psi] falling pressure as cylinder empties. **THE ALARM WILL NOT FUNCTION IF THE UNIT INLET PRESSURE IS BELOW 1.7bar [25psi]**. When side B is active and supplied above 1.7bar [25psi] with the alarm switch in the upper reset position, the alarm will remain silent until the supply pressure to port B falls to below 1.7bar [25psi] at which point the audible alarm will sound.

## »»» PORT ADAPTORS

The following hoesetails and adaptors can be purchased separately.

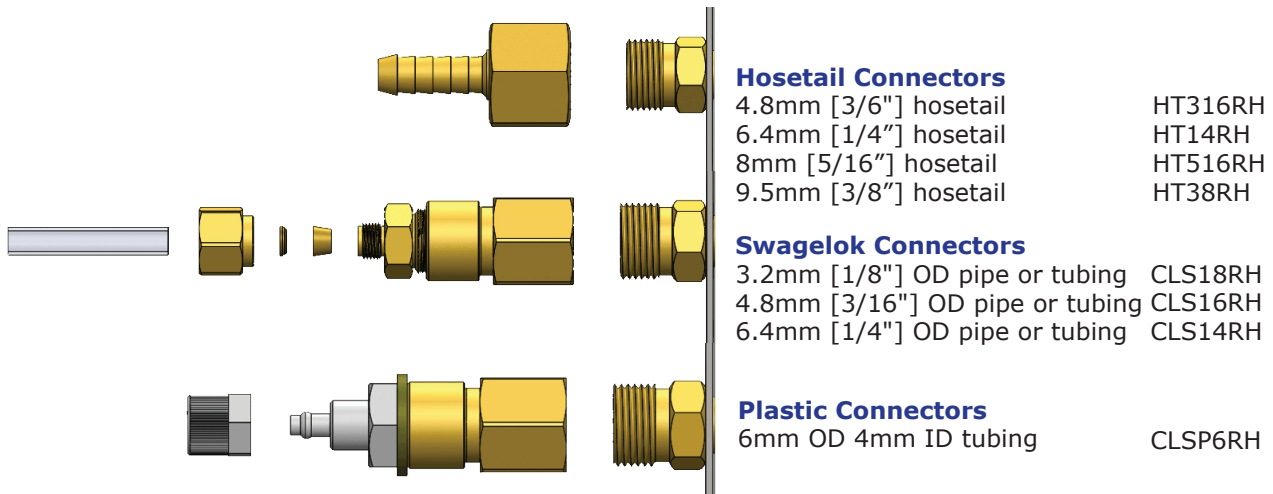
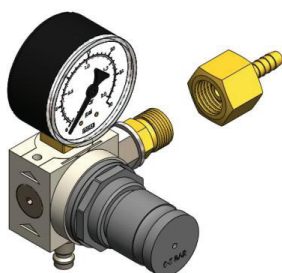

Fig.4

## »»» OUTLET PRESSURE MODULES (OPM's)



0-35 PSI Output Pressure Unit for Pneuchange Trio  
0-100 PSI Output Pressure Unit for Pneuchange Trio

NTC OPM35  
NTC OPM100

Fig.5

## »»» FILTER ASSEMBLY (recommended option)

Inlet filters fitted to regulator outlet ports prevent foreign particles in the gas supply becoming trapped in the valve or regulator seals, causing malfunction. Filters will prolong the life of your PNEUCHANGE unit and can be purchased in pairs.

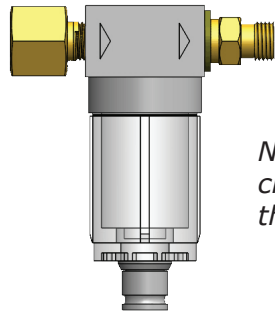

Filter Assy  
(Part No.  
CFILT38FR6RHLR)

*N.B. Before removing the filter bowl for cleaning or renewal of filter element, ensure that the inlet line pressure is vented.*

Fig.6

## »»» FREQUENTLY ASKED QUESTIONS

- Q.** Does the Pneuchange unit require electrical power to work?  
**A.** The Pneuchange unit does not require mains electrical power to operate. For the PC15, PC30, PC60 and PC100 Pneuchange units, an on board 9V PP3 battery (supplied) powers the integral alarm.
- Q.** What does the '-VFC' part number suffix mean?  
**A.** Pneuchange units with a VFC suffix are fitted with Volt Free Contacts for use with remote alarms. A battery is not required and the integral buzzer is not present. The Pneuchange unit is supplied with a quick release socket connector.
- Q.** Do you have a remote alarm for use with Pneuchange units PC15-VFC, PC30-VFC, PC60-VFC and PC100-VFC?  
**A.** We do not currently have our own remote alarm but we are looking to develop a battery powered one in the future. Please contact us if this is of interest.
- Q.** What is the maximum input pressure to a Pneuchange unit?  
**A.** 6.9bar [100psi].
- Q.** Do I need to use a pressure regulator on the gas cylinder?  
**A.** Yes. As the maximum input pressure for a Pneuchange unit is 100 psi, a regulator needs to be fitted to the gas cylinder. CO2 gas cylinders are typically 50 to 60bar [725 to 870psi] and nitrogen is typically 250bar [3625psi].
- Q.** What are the input and output port connections?  
**A.** The input and output port connections are 3/8" BSPP with a 60 degree cone. However, Pneuchange units are supplied with brass hosedails to suit 6.4mm [1/4"] ID hose. Other size hosedails and adaptors are available to purchase separately.
- Q.** What gases can I use the Pneuchange unit with?  
**A.** Pneuchange is designed for use with inert gases.

## »»» FREQUENTLY ASKED QUESTIONS CONTINUED

**Q. Can I use the Pneuchange unit with Oxygen?**

**A.** No. The Pneuchange unit is not suitable for use with oxygen. However, our new high pressure change-over unit is suitable for oxygen. Please contact us for details.

**Q. Can I use the Pneuchange unit for Hydrogen?**

**A.** No. Hydrogen is a flammable gas and the Pneuchange unit is not suitable for flammable gases. However, our new high pressure change-over unit is suitable for flammable gases.

**Q. Can the Pneuchange unit be used with CO2?**

**A.** Yes. The Pneuchange unit was specifically designed to be used with inert gases including CO2.

**Q. What is the most common application for the Pneuchange units?**

**A.** Pneuchange units are most commonly used to provide a continuous supply of CO2 to CO2 incubators in laboratories.

**Q. When should I replace my Pneuchange units?**

**A.** In line with BCGA recommendations, we recommend that all Pneuchange units and associated gas control equipment is replaced every 5 years.

**Q. Can you service/repair my broken Pneuchange unit?**

**A.** As the Pneuchange units contain so many components, it is not cost effective for us to service Pneuchange units.

**Q. Why are the needles in the pressure gauges bent?**

**A.** If a pressure supply of over 6.9bar [100psi] has been applied to the Pneuchange unit, this will over pressurise the components including the gauges. The Pneuchange unit must not be used and should be replaced.

**Q. How is the alarm powered?**

**A.** On the PC15, PC30, PC60 and PC100 Pneuchange units, the integral alarm is powered by a 9V PP3 battery (supplied).

**Q. Why will the integral alarm not sound?**

**A.** Ensure that a fully charged battery is correctly fitted into the battery compartment. Also ensure that the alarm switch is in the correct position. (Centre position turns alarm off). Consult manual for full details.

**Q. How do I dispose of the battery once it has run out?**

**A.** Batteries should be disposed of in accordance with WEEE directives if inside the EU. For advice, contact your waste disposal supplier.

**Q. Can the Pneuchange unit be used for medical applications?**

**A.** The Pneuchange unit is not designed for contact with patients.

**Q. Does it matter which inlet port is utilised first?**

**A.** No, The Pneuchange will automatically feed from the first connected cylinder.